



CoolKatzCraft

Mini Album

An album using the paper collection

“Charmed”



We are very happy for you to make and sell your projects, however this project and the PDF tutorial may not be reproduced in any format or on any platform without the written permission of CoolKatzCraft Ltd.

If you are sharing your completed project on any platform, please acknowledge CoolKatzCraft as the originator of this project.

*We would love to see your finished projects in our Facebook group: CoolKatz*

## Useful tools

An accurate paper trimmer, with the ability to place the cutting blade, wherever you choose along the cutting line; with both imperial and metric measurements.

Craft knife, scissors, corner rounder, craft clamps, pencil, CoolKatz multi-purpose Teflon tool, rubber, black sharpie pen, adhesive eraser and glossy accents.

Craft support range®: ¼” hinge spacers.

Craft support range®: Spine score guide.

Craft support range®: Corner spacers.

Craft support range®: Half measure strips.

Craft support guide®: 12” or 8” Alignment strips.

### Dies used:

Large swivels

Curved photo slots, set 1

Folio strip set, using large & small size

## Adhesives:

We recommend strong double-sided acid free tape 6mm and 9mm; CoolKatz sticky paws Pro tape however the red line tape is also satisfactory. *Finger lift tape is not strong enough.* When sticking on decorative paper we recommend a bookbinding glue

If you are making 3D projects/multi fold album covers, then you can use either our acid free black frame tiger tape, Architape® for the hinges as well as or instead of cardstock.

**Neodymium Magnets:** Please be aware that these are brittle and can break if allowed to snap together. The best way to separate them is to slide each magnet apart. They are very strong and must be kept out of the reach of children and pets.

If they are inhaled or swallowed seek medical advice immediately.

This PDF provides comprehensive instructions for the album assembly, cutting guide and page decoration. This means that you are able to work at your own pace.

If you have any questions or are unsure about anything please do ask, that’s what we’re here for.

We really hope you enjoy the project and look forward to seeing your finished projects.

### Grey board cover set:

Covers: 8½" x 6½", Spine: 6½" x 1¾"

### Step 1

#### Cover assembly.

Begin with covering three edges of each grey board cover and the top and bottom of the spine.

Using the ¼" hinge spacers, attach the covers to the spine *fig 1 – 3*.

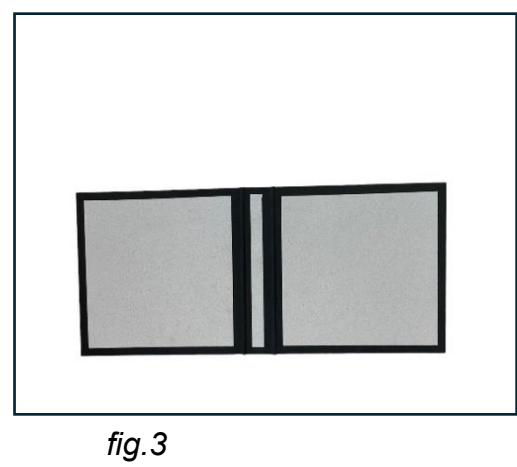
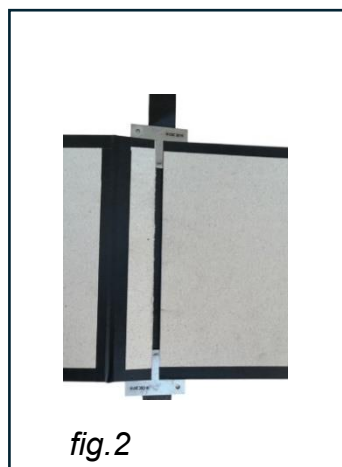

### Step 2

Cut black card @ 6¼" x 4" and fix over inside spine to create a "spine liner", make sure everything is glued down and burnished very well *fig.4*. Do not use the pointed/rounded end of your burnishing tool in the hinges, once the card is stuck and the glue has had some time to set, very gently bend the hinges, *use the side* of your burnishing tool to burnish further.

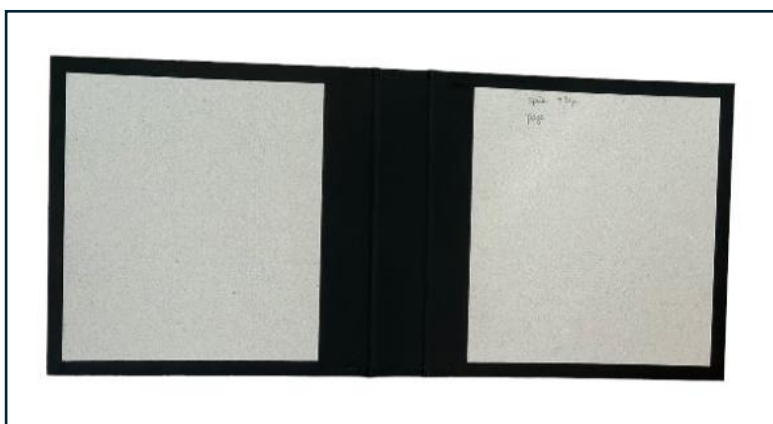

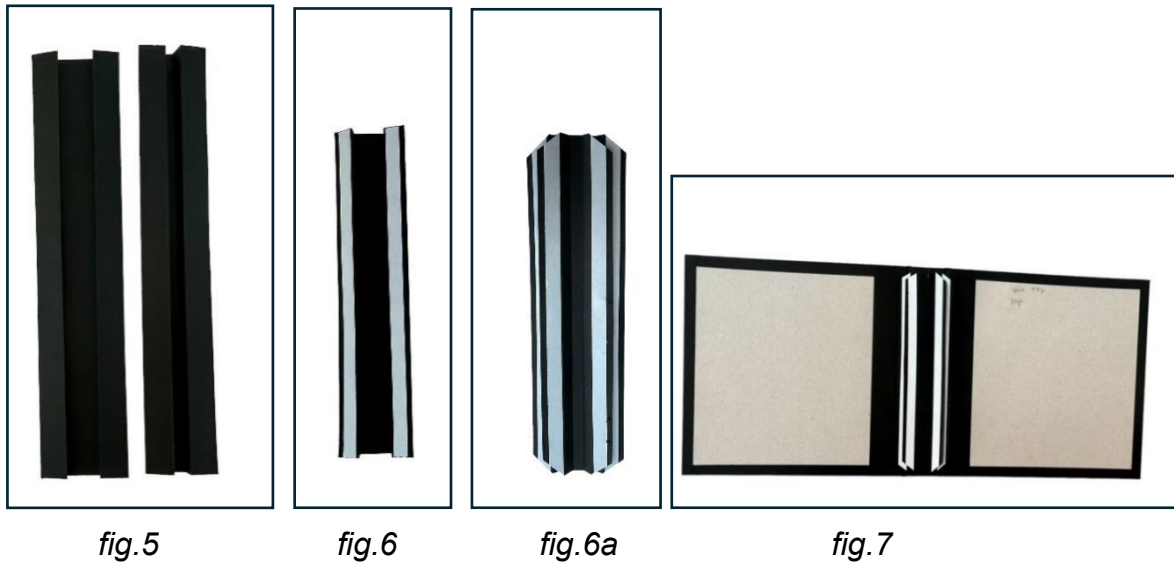

### Step 3

#### Spine hinge stack assembly.

Use hinge stack die (trim spine height to 6") or cut black card as follows:

Part A: cut @ 6" x 1<sup>3</sup>/<sub>4</sub>", place portrait layout, score at: 1/2", 3/4", 1", 1<sup>1</sup>/<sub>4</sub>"

Part B: cut @ 6" x 2<sup>1</sup>/<sub>4</sub>", place portrait layout, score at 1/2", 3/4", 1<sup>1</sup>/<sub>2</sub>", 1<sup>3</sup>/<sub>4</sub>"

Burnish folds on both parts *fig. 5*. If you are not using glue to stick your pages in, then apply double sided tape to both sides of the half inch flap *fig. 6*.

Stack the smaller spine centrally on top of the larger spine and stick, then trim each corner off the half inch flaps as *fig 6a*.

Stick the assembled spine centrally onto the spine of the inside cover *fig. 7*. *you can use alignment guides for accuracy.*

### Step 4

#### Pocket pages

Pocket pages are designed to slot onto the spine hinges and once fixed on the spine create an additional pocket for the page inserts.

**From black card:** Cut 8 pieces: 6<sup>1</sup>/<sub>2</sub>" x 7<sup>3</sup>/<sub>4</sub>". **N.B.** to make sure your pages are all precisely cut, place a piece of tape on your trimmer arm and butt up each piece of card to it before cutting *fig. 8*.



fig. 8

With the card *portrait layout*, score at 6" down one side, stick together to create pocket page, final pocket page size will be 6"(H) x 7<sup>3</sup>/<sub>4</sub>"(W).

Number each page side and orientation.

**Do not stick your pages in before decorating.**

### Step 5

**Inside pocket page tabs**, these fit inside each pocket page and you can add tabs and other decoration afterwards.

**Black card:** cut 4: 5<sup>1</sup>/<sub>4</sub>" x 7<sup>1</sup>/<sub>2</sub>", you can cut 2 pieces from one piece of A4.

Once you have cut these, put them away in a safe place so you don't use them by mistake.

### Step 6

#### **Black card cutting guide for the whole album**

*Cut all your black card, tick off as you go and make sure you clearly mark each piece by page number and directional arrow e.g. page 1 flap. Use a white gel pen/pencil for clear marking. Keep each page separate.*

#### **Inside covers – front and back,**

These have vertical pockets

**cut 2 of each piece.**

Bottom pocket: 6<sup>3</sup>/<sub>8</sub>" x 2<sup>1</sup>/<sub>2</sub>"

Top pocket: 6<sup>3</sup>/<sub>8</sub>" x 7"

Front & Back strip: 6<sup>3</sup>/<sub>8</sub>" x 1<sup>1</sup>/<sub>8</sub>"

Spine: 6 3/8" x 1<sup>5</sup>/<sub>8</sub>"

## Page 1

This has a front flap and inner flap, when sticking the flap hinges make sure everything closes easily, you may need to trim a smidge off one end.

**Flap A:** 6" x 6½", *landscape layout* score ½" down one side. Stick to the spine hinge edge (L) of the page *fig.10*

**Flap B:** 6" x 7¼", *landscape layout* score ½", then stick to outside (R) edge of page 1 *fig.9*

**Front Flap A: horizontal pocket:** 6" x 2"

**Inside Flap A: Horizontal pocket:** 6" x 2" (trim a smidge off)

**Front Flap B: Vertical pocket:** 6" x 2"

**Inside Flap B: Horizontal pocket:** 2" x 6¾" (trim a smidge off)

**Base Page: Horizontal pocket:** 2" x 7¾" (trim a smidge off)



fig.9



fig.10

## Page 2 & 3

These are known as "catch up pages" and are a great way for paper saving.

**Black card:** cut 2 of each size

**Bottom vertical pocket:** 6" x 5¾"

**Top vertical pocket:** 6" x 2½"

## Page 4

Inner frame bottom pocket: 3" x 5½"

Inner frame top pocket: 1½" x 5½"

## Page 5

**Front flaps:** cut 2 pieces @ 3½" x 7¾", portrait layout score each piece at 3", stick from top and bottom edge of the page fig. 11.

**Inner front flap horizontal pockets:** cut 2 pieces @ ¾" x 7¾"

**Inner side flaps:** cut 2 pieces @ 4<sup>3/8</sup>" x 5<sup>15/16</sup>", portrait layout score 3<sup>7/8</sup>", stick on each side of page edges **\*\*NB before sticking you may need to trim a smidge off the height of the flaps so the top flaps can close easily** fig. 12.

**Magnet mat base:** 3 ¼" x 2" – you may need to trim this.

**Base Page, diagonal pockets:** 6" x 7<sup>11/16</sup>" cut as fig. 13 -fig. 14



fig.11



fig.12

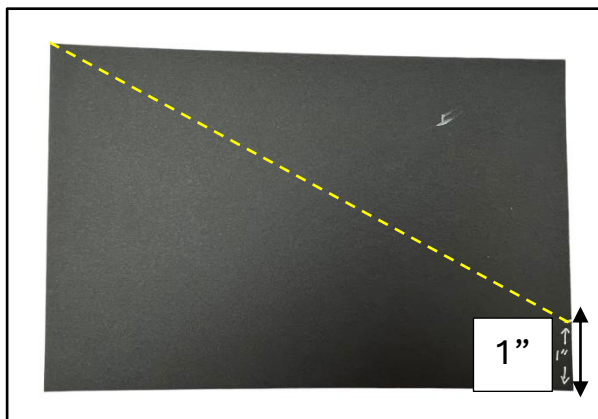

fig.13

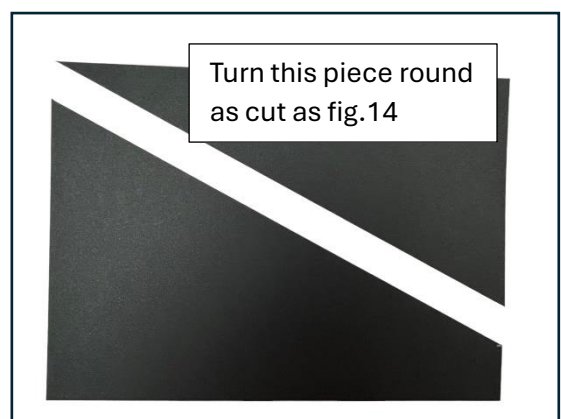

fig.13a

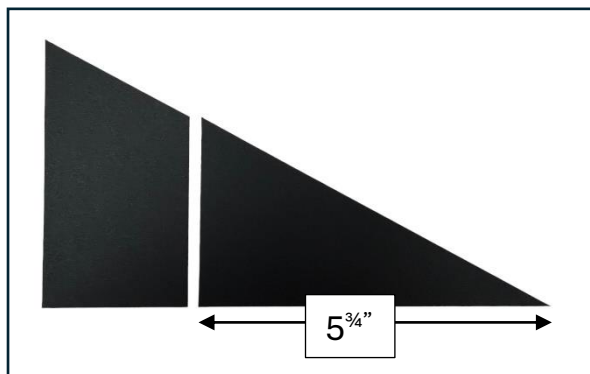
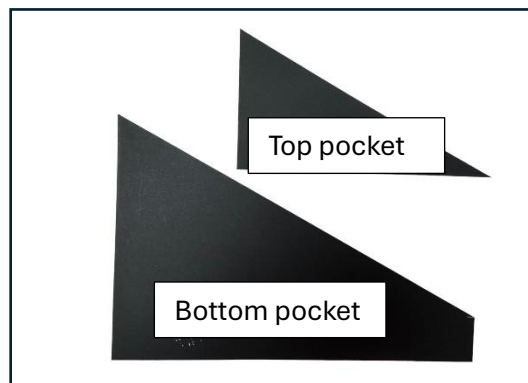

fig.14



**Page 6**

**Bottom horizontal pocket cut:**  $3\frac{1}{2}$ " x  $7\frac{3}{4}$ "

**Top Horizontal pocket cut:** 2" x  $7\frac{3}{4}$ "

**Page 7**

**Bottom vertical pocket:** cut 6" x  $4\frac{1}{2}$ "

**Top vertical Pocket:** cut 6" x 2"

**Page 8**

**Black card:**

**Flip Flap:** 6" x  $6\frac{1}{4}$ ". *Landscape layout* score at  $5\frac{5}{8}$ " stick in 1" from each side of page edge fig.15.

**Base page, vertical pocket:** 6" x 1"

**Inside flap, bottom horizontal pocket:** 2" x  $5\frac{3}{4}$ "

**Inside flap, top horizontal pocket:** 4" x  $5\frac{3}{4}$ "





## Step 7

Please read this before beginning your page assembly and decoration.

**Always measure twice and cut once.**

*If something doesn't look right when measuring your paper from instructions given here always double-check before you cut;* we have double checked measurements but always on the side of caution.

If you cut a piece in the wrong place, don't panic! You can do an invisible repair, using double sided tape and burnishing well with a multi-purpose tool; we have a YouTube guide showing how to do an invisible repair.

*When using the cutting guides, **cut all piece's page by page, and assemble one page before going on to the next one to avoid confusion.***

We allow 1/16" border for pages, flaps, pockets etc. We like to ink our edges with a coordinating colour before sticking decorative paper or you can use a pen.

*The cutting guides are designed to make maximum use of your papers, so make sure you mark each piece that is earmarked/cut for designated pages for pages further on.*

**Tick off each stage as you go** and have a separate pocket folder for each page before you start if you plan on doing all your cutting first.

## How to use the PDF.

For each page there will be a picture of the finished page and inside flaps if relevant.

The cutting guides are designed to help you get the best use out of your decorative papers.

There are also page assembly instructions.

If you have any questions, please ask.

**\*\*Before starting any decoration,** take 2 sheets of “Sit for a Spell” and trim off a bottom strip from each piece *fig 16*. **Save these strips for the inside covers.**

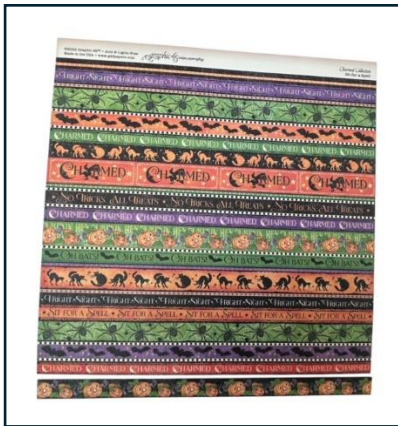
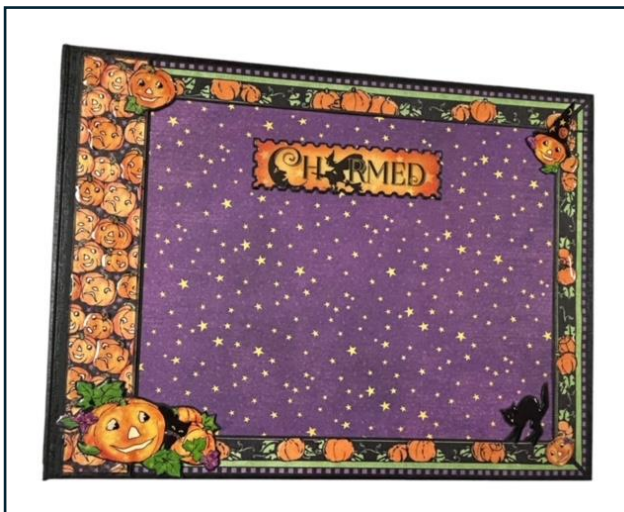

fig.16

### Outside cover.



Add additional fussy cut embellishments once you have completed all the album decoration as there will be papers left over to use.

I usually decorate the covers inside and out before decorating the pages, and I add embellishments once I have finished all the page decoration. I use glossy accents before sticking in the pages so that the cover can lie completely flat to allow for even drying on a flat surface.

## 8" x 8" Papers

"Charmed" "If the broomstick fits" "Let's Party" striped side.

Cut out the frame *fig.17*



fig.17

Place cut frame onto cover to get correct size, *fig.18*. Cut frame as *fig.19*.

Cut border strips and front cover (purple with yellow stars) *fig.20*.

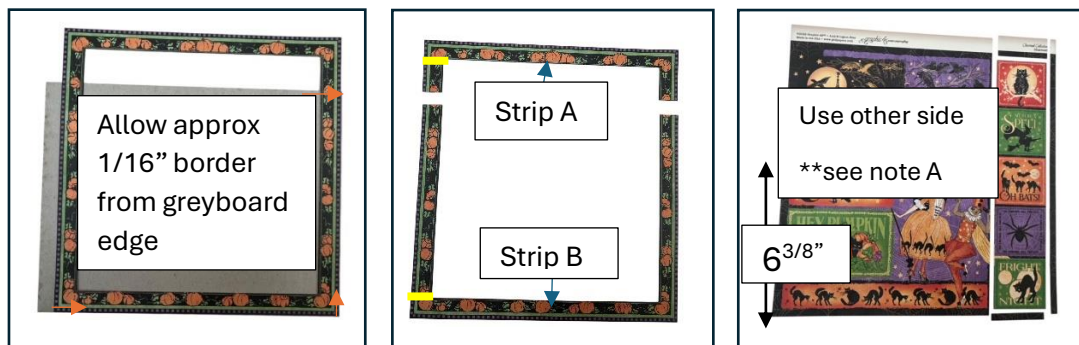

fig.18

fig.19

fig.20

Edge long border strips with ink or black pen, do not do the short edges.

\*\*Note A: trim off signature strip, turn the paper landscape layout and stick purple paper 1/16" in from right hand edge of cover *fig.21*.

Stick strip "B" first along the bottom edge of the cover *fig.22*. Then stick strip "A" as and use remainder of strip left to increase strip length.

Use a black pen to create a faux mitred corner effect *fig.23*.



fig.21

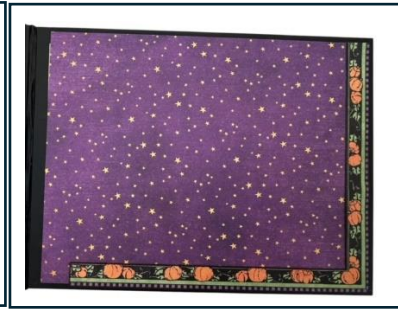

fig.22

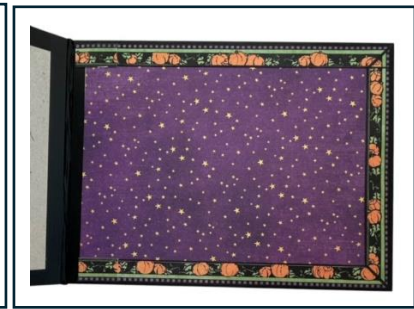

fig.23

When cutting your pumpkin strips, cut from the back so you can choose which images to keep for later use *fig.24*.

Cut your decorative strip from (*fig.20*) as *fig.25*, if you don't like the spider image stick a cat on top! *fig.26*.



fig 24



fig.25



fig.26

Stick the pumpkin strip on the front cover and the images onto the spine.

Stick the striped paper 1/16" in from edge of back cover. Stick pumpkin strip.

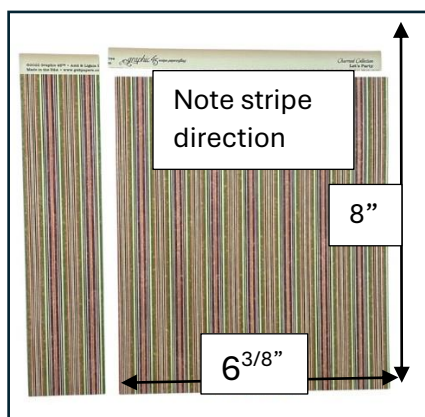

## Inside Covers

These are the same for both, just mirrored.

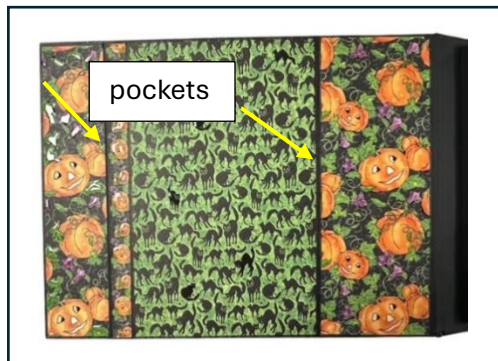

Inside front cover

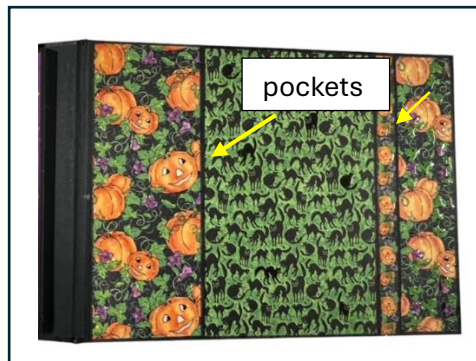

Inside back cover

## 8" x 8" Papers

“Sit for a spell” green & black cat side, use one of the pieces you trimmed the bottom strip from.

“Hey Pumpkin”

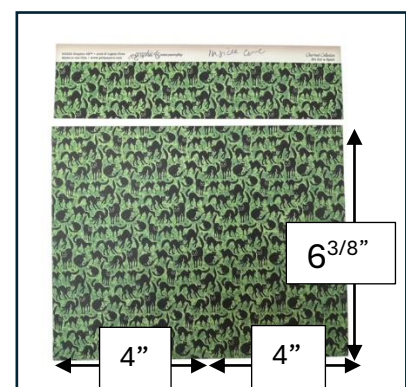

## Front inside cover

Stick the 1<sup>5/8</sup>" pumpkin strip 1/16" in from the outside edge of the cover *fig.27*

Stick pumpkin border strip, 1/16" in from the edge of the black card bottom pocket *fig.28*.

Mat the green paper and then stick as a vertical pocket, \*\*make sure you don't go into the cover hinge when sticking *fig.29*.

Mat the 2<sup>3/8</sup>" strip onto the black card top pocket and stick as a pocket *fig.30*.



fig.27



fig.28

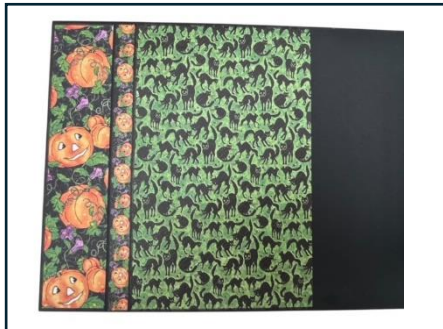

fig.29



fig.30

Repeat the process for the inside back cover *figs.31-34.*



fig.31



fig.32

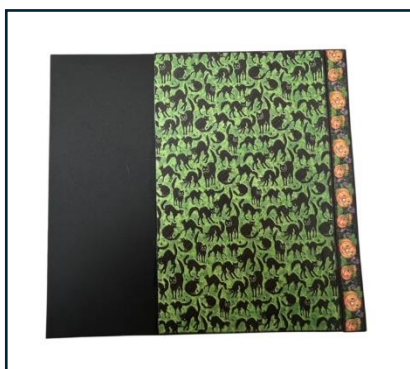

fig.33

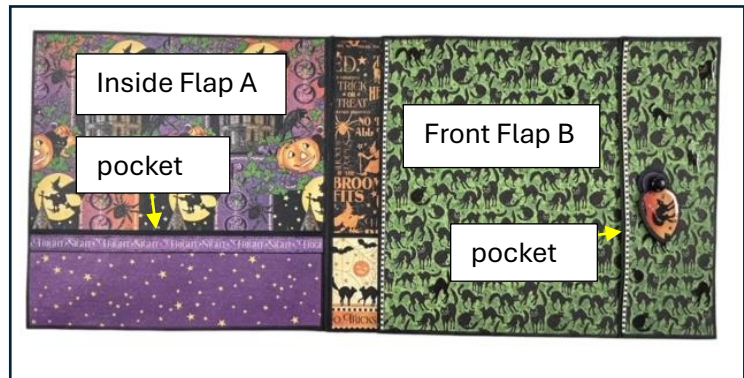

fig.34

**Page 1** This has a front flap closed with a swivel then an inside flap with horizontal pockets.



Front view



Front Flap A opened out

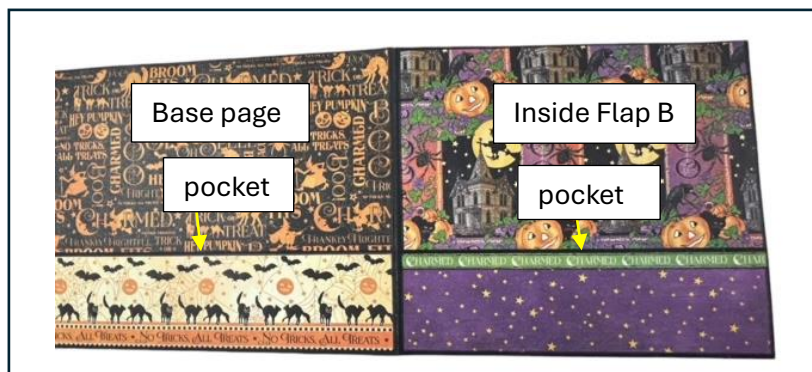

Front Flap B opened out

Stick the 2 swivels back-to-back. Make up your faux brad and add one or two washers, for a tighter swivel use one or no washers, or use a metal brad if preferred. Mat and layer the folio circles. Poke the brad through the swivel and then through the folio hole - you may need to enlarge it slightly. Trim the brad legs and burnish firmly Figs 35-38. (Image shows different shape swivel). Don't fix swivel if you want to cut decorative mat from paper left at the end,



fig.35



fig.36



fig.37



fig.38

8" x 8" papers

"Hey Pumpkin", "Oh Bats", "So Spooky" (witches side),"Sit for a Spell" Use the other piece strip trimmed off earlier,"Charmed" (purple side).

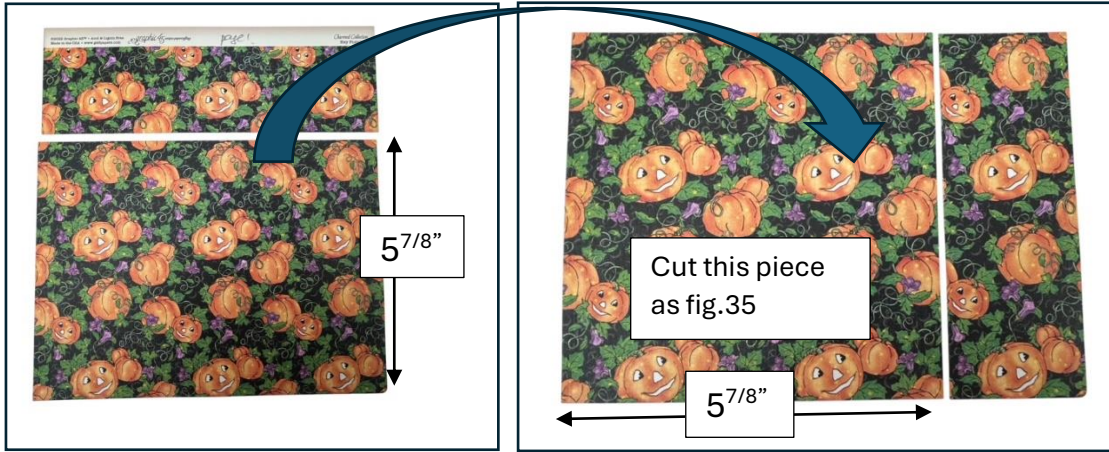
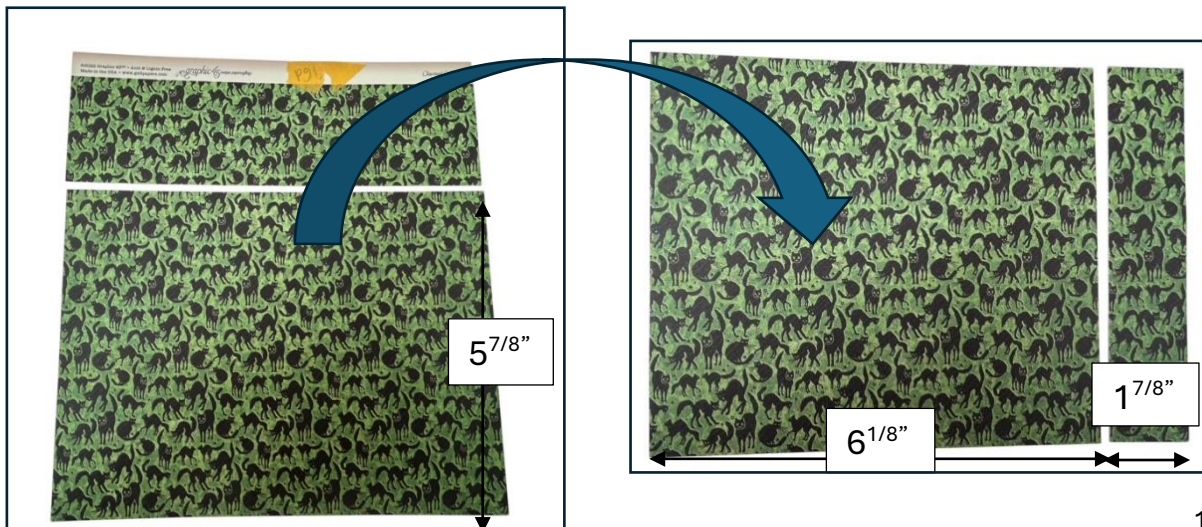
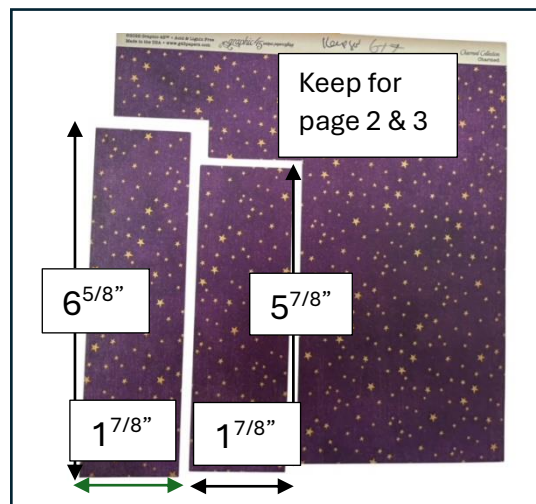

fig.39





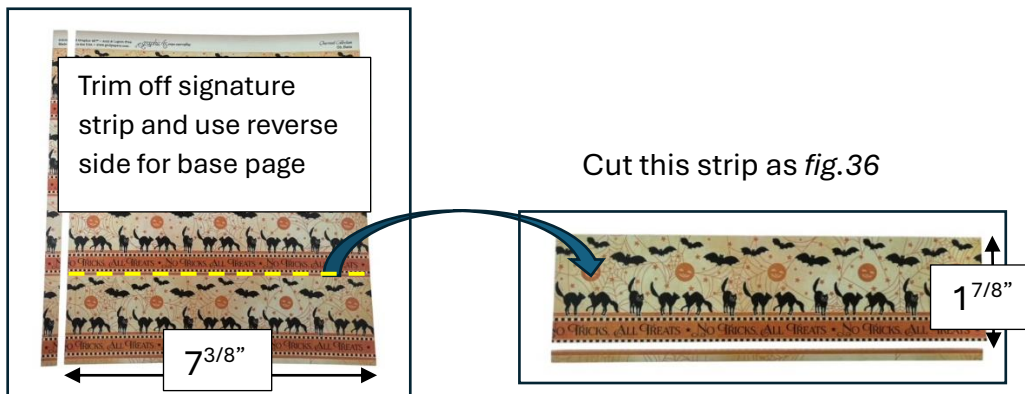

fig.36

Stick the pumpkin paper from the top edge of the flap (allow 1/16" border) *fig.37*

Mat the paper onto card and stick as a horizontal pocket\*make sure you have the paper up the right way up as you're matching the pattern.

Stick the greenpaper onto the front of the flap *fig.38* then mat and layer the vertical pocket and stick as a pocket. Make up the swivel mechanism, add the brad and stick centrally onto the vertical pocket, making sure the flap opens easily.



fig 37

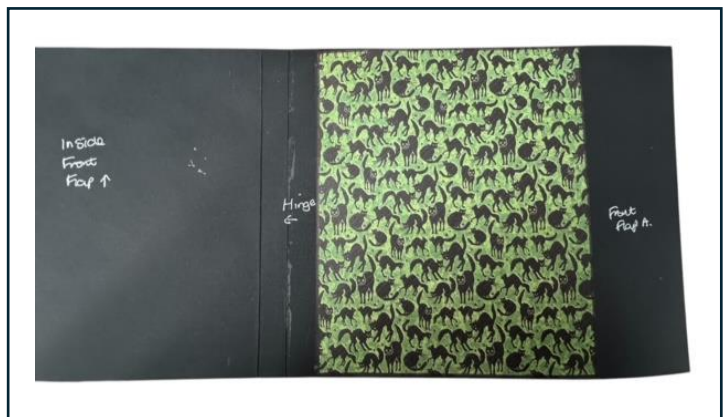

fig 38

With the text facing up, stick the paper onto the base page *fig.39* mat and stick the horizontal pocket *fig.40*



fig.39



fig.40

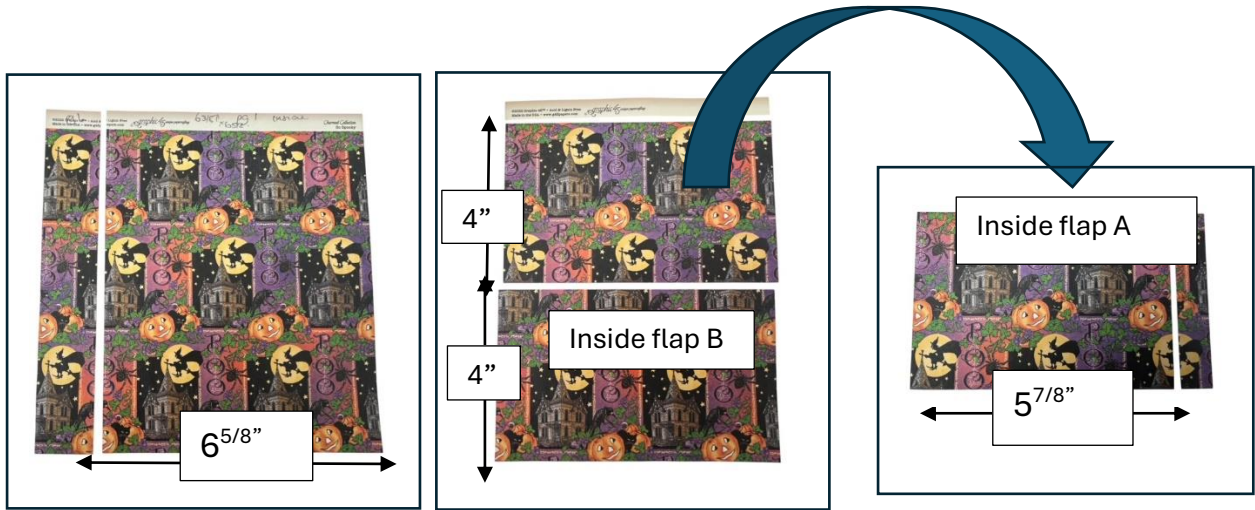

Stick the witches paper from the top edge of inside flap B *fig.41*, then stick the purple star horizontal pocket.

Stick the witches paper from the top edge of inside flap A, then stick the purple horizontal pocket *fig.42*.

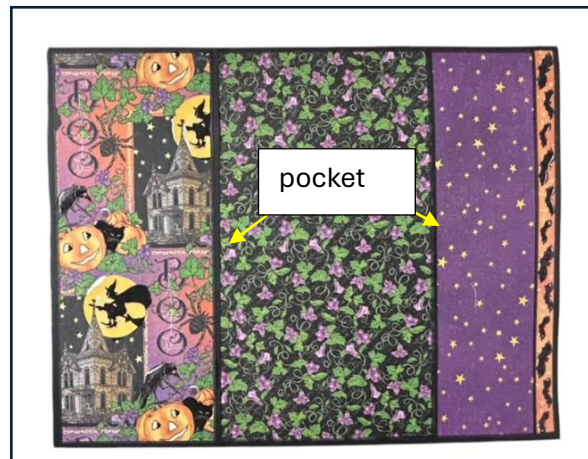
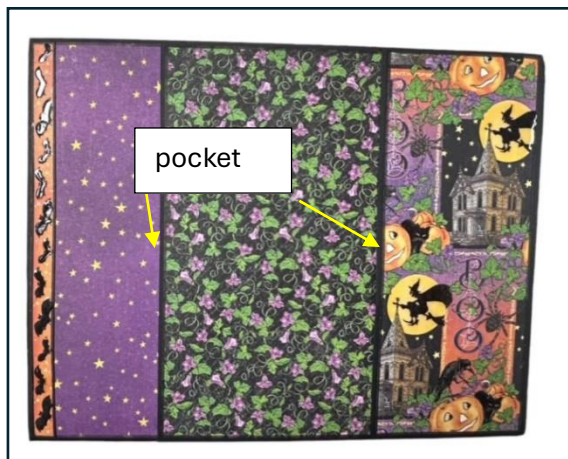

fig.41



fig.42

**Pages 2 & 3** These are known as “catch up pages” with pattern matching and vertical pockets.



8" x 8" papers

"So Spooky" x 2 sheets, "Charmed" from page 1

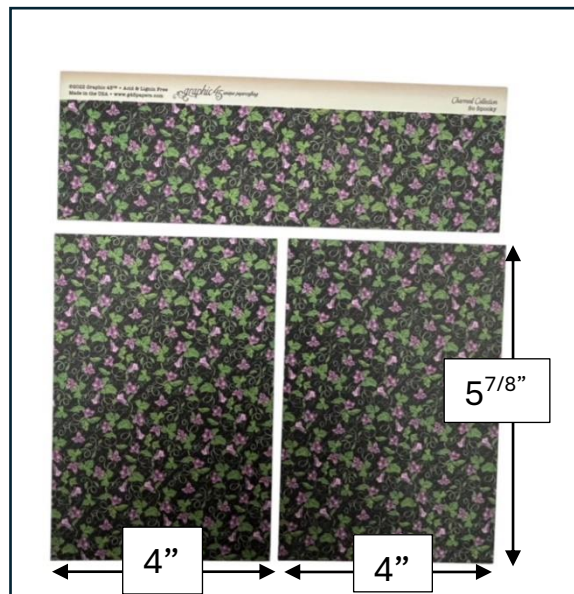
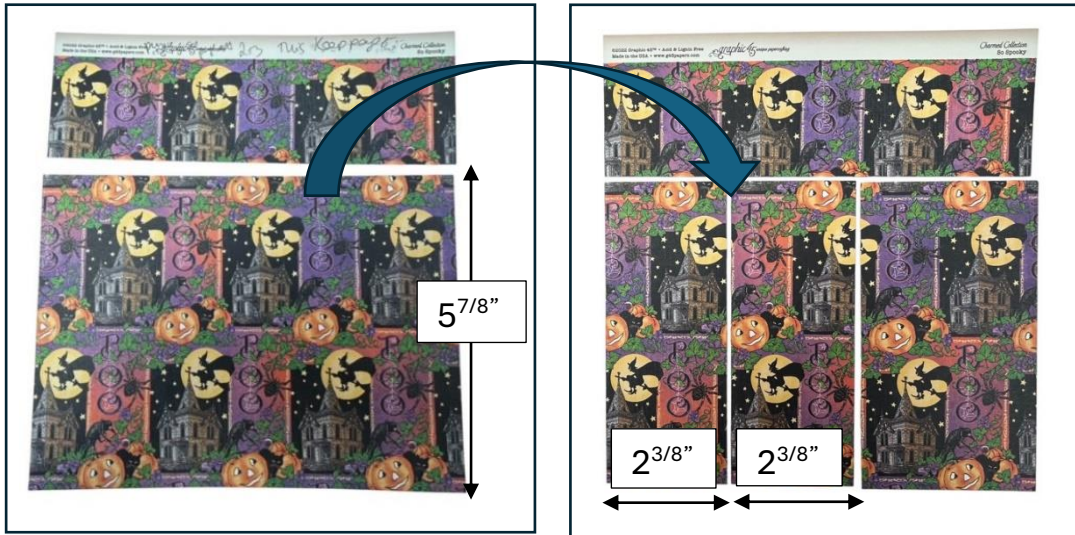

Page 2

Stick the purple paper in from the edge *fig.43*, mat the floral paper onto the card and stick as a vertical pocket *fig.44 & 45*. Mat the witches paper and stick as the top pocket, **making sure you have the correct piece for pattern matching.**

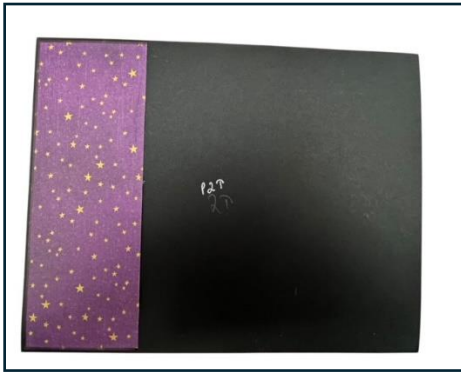

fig.43



fig.44

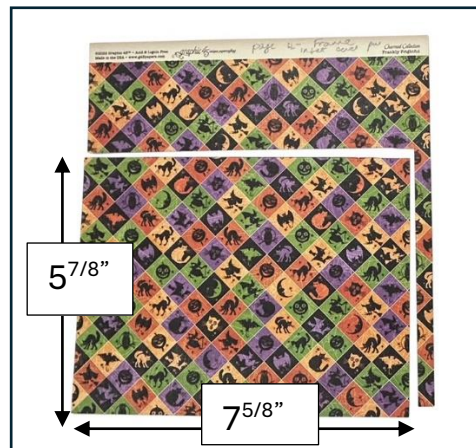
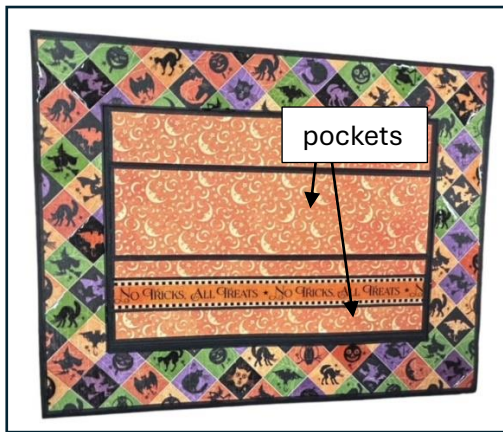

fig.45

Repeat the same steps for page 3, figs 44-46 then mat witches paper and stick as the top pocket.

**Page 4.** This has an inset pocket frame.

8" x 8" papers "Frankly Frightful"



Use a 1" corner spacer to mark out frame width easily.



fig.46

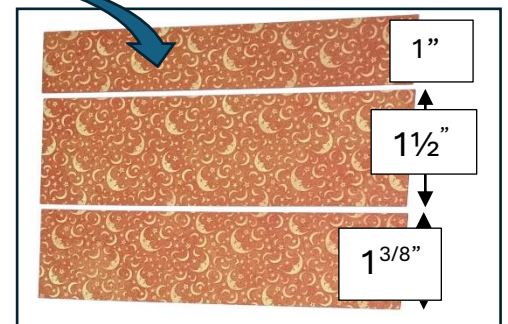

Cut a 1" width frame, use a 1" corner spacer for accurate and quick marking.

Stick the frame to the base page *fig.47*.

Stick the orange paper to the top of the inside frame, allow 1/16" gap from frame edge. Mat orange paper from the top edge of the bottom pocket, then stick as a pocket *fig.48*. Mat and layer top pocket.

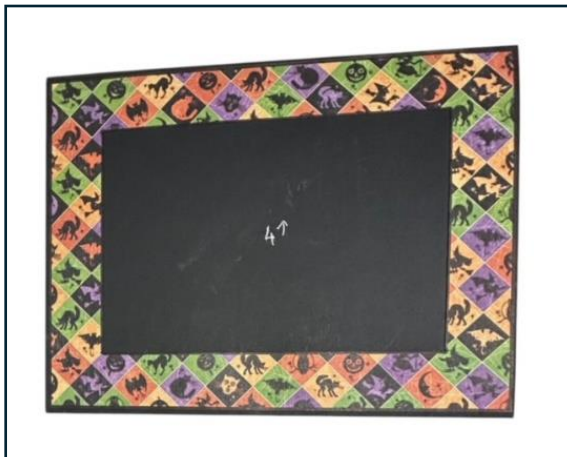

fig.47



fig.48

**Page 5.** This is a “cross flap” page closed with a “magnet mat”.



Front view, lift up and lift down flap



Inside view with flaps opened up & down

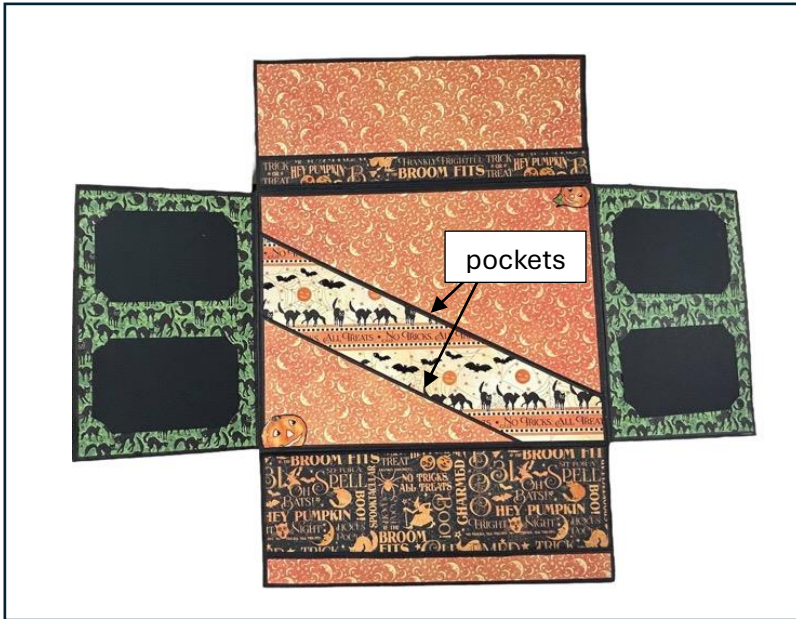

View with inner flaps opened out.

8" x 8" papers.

"Sit for a spell" (green side),"Oh Bats" x 2 sheets, "Frankly Frightful" x 2 sheets.

Magnet mat cut from "Charmed", make sure you cut into the paper to only cut that image out as the keep the remainder for page 6.

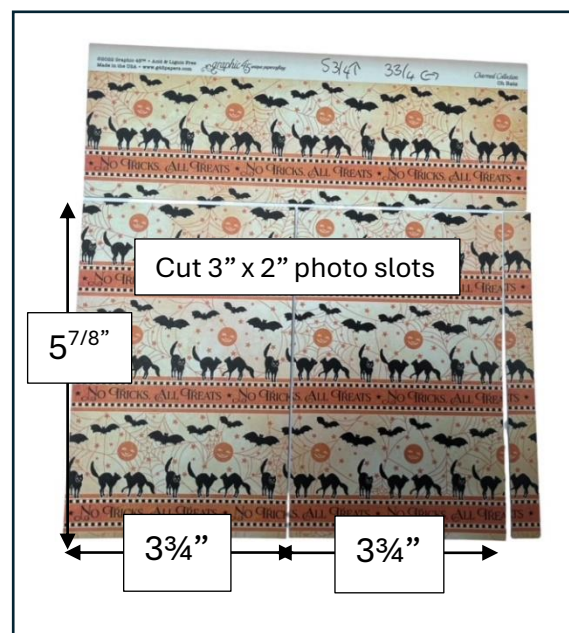
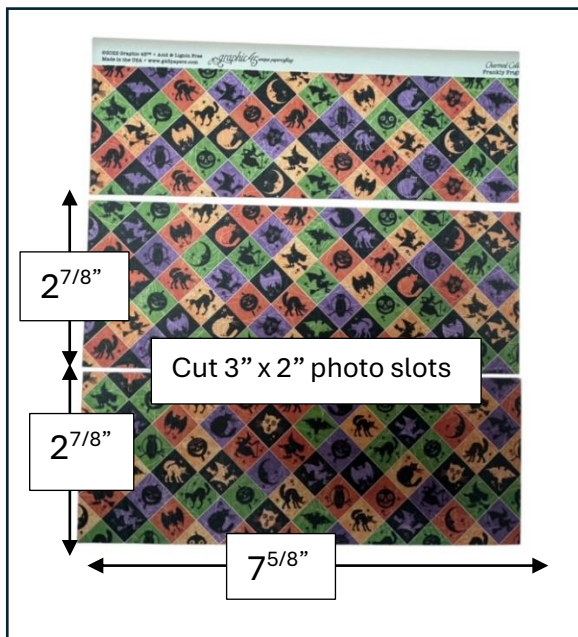

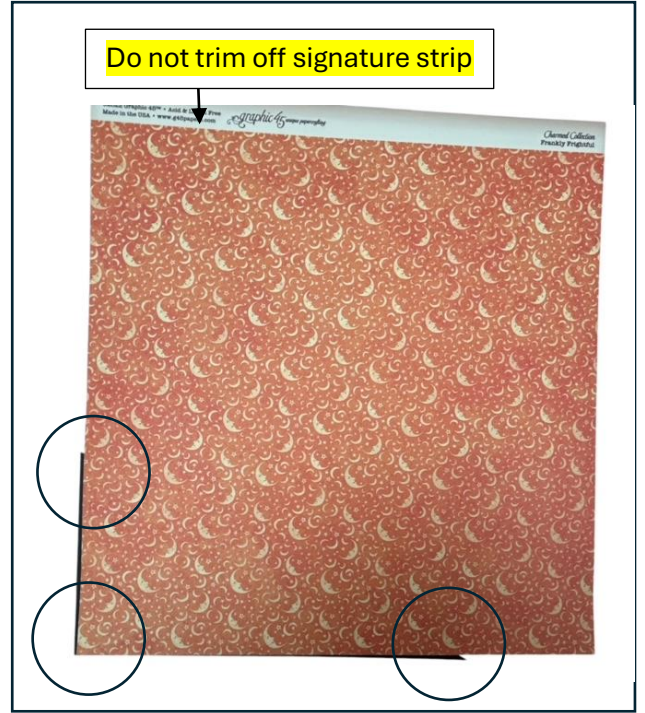
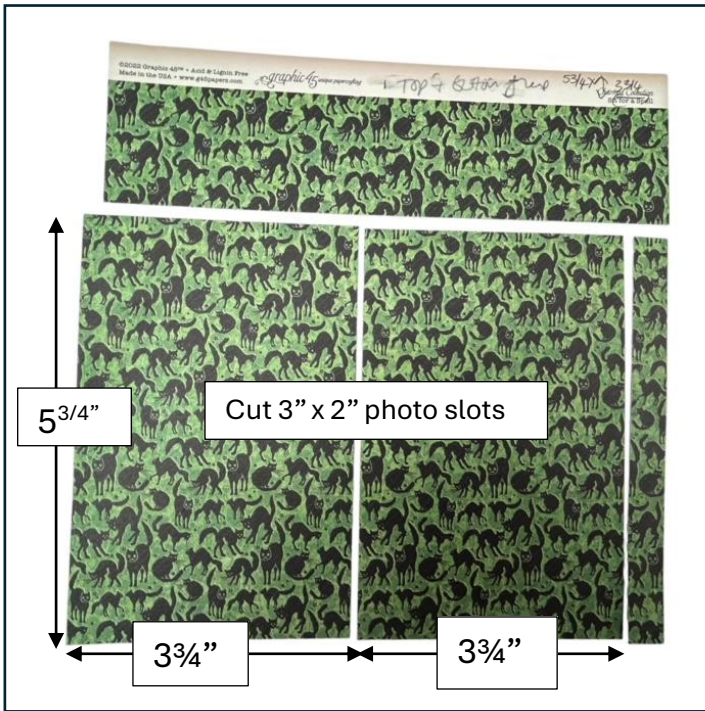

Line up paper as in *fig.49*, so width is  $3^{5/8}$ " then turn and cut as *fig.50*.



fig.49

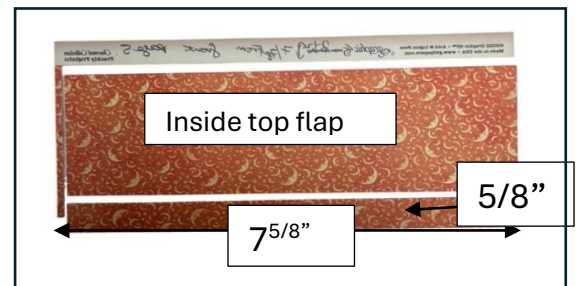
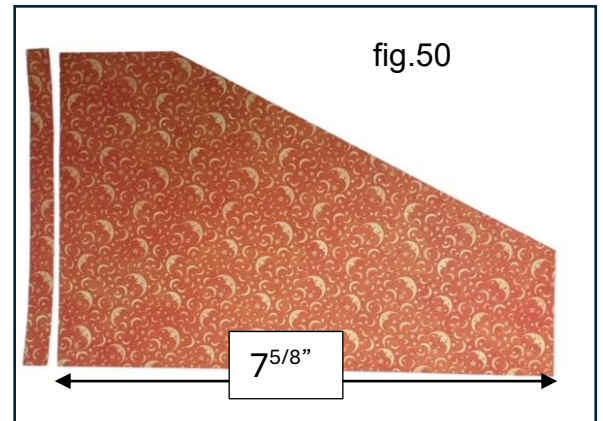

fig.51

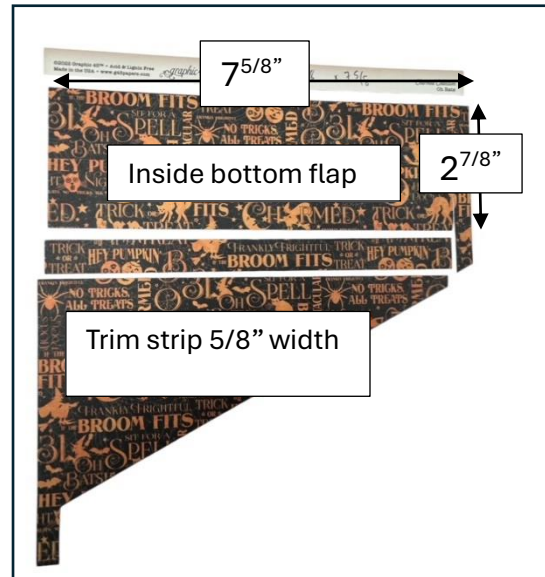
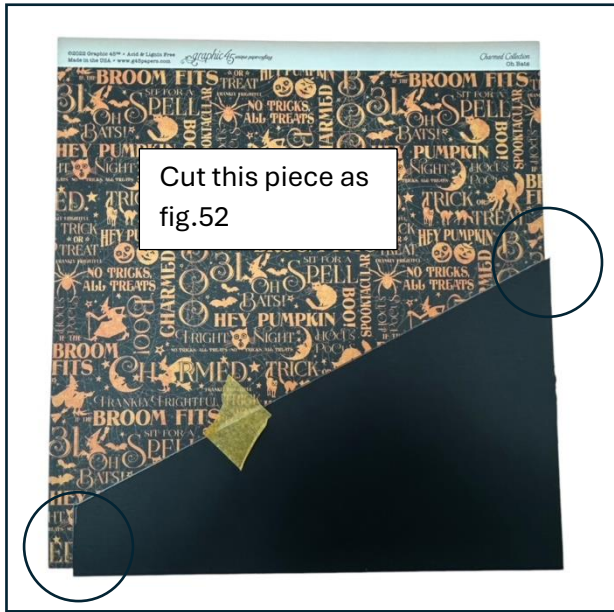

fig.52

Stick 4 magnets onto the back of the black card *fig.53* once stuck, cover with a piece of decorative paper (do this at the end).

Open up the flaps and place magnets by sliding behind the flap as *fig.54* and repeat for flap on the other side. This may be enough to hold flaps closed once pictures are added but for belt and braces add to magnets onto the base page as *fig.55*.



fig.53



fig.54

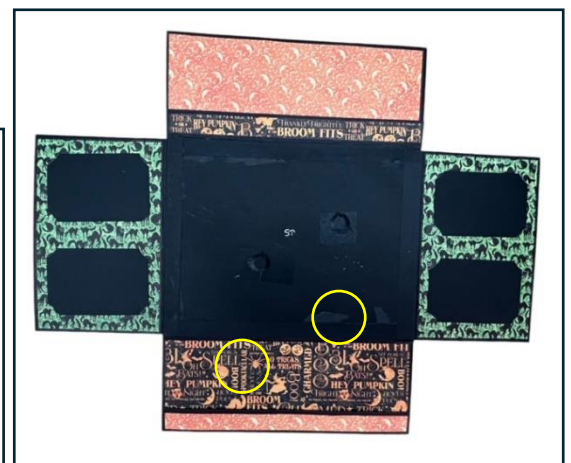

fig.55

Once you have cut all the photo slots and matted the decorative paper onto the horizontal pocket strips, begin page assembly.

Stick decorative papers to front up and down flaps.

Stick papers to the inside of the flaps and stick the horizontal pockets.



Stick the “Oh Bats” cats facing up onto the front of the lift out flaps, stick the green paper onto the inside of the lift out flaps.

With the orange side facing up, stick onto the base page.

Mat the papers onto the bottom and top diagonal card, then stick as diagonal pockets.

**Page 6.** A “catch up” page with horizontal pockets.



**8" x 8" papers**

“Charmed” remainder from page 5, “Let’s Party” people side.

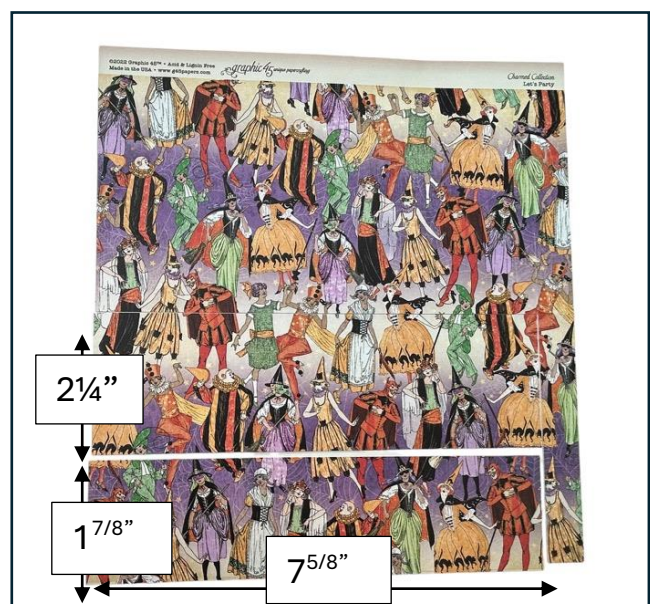
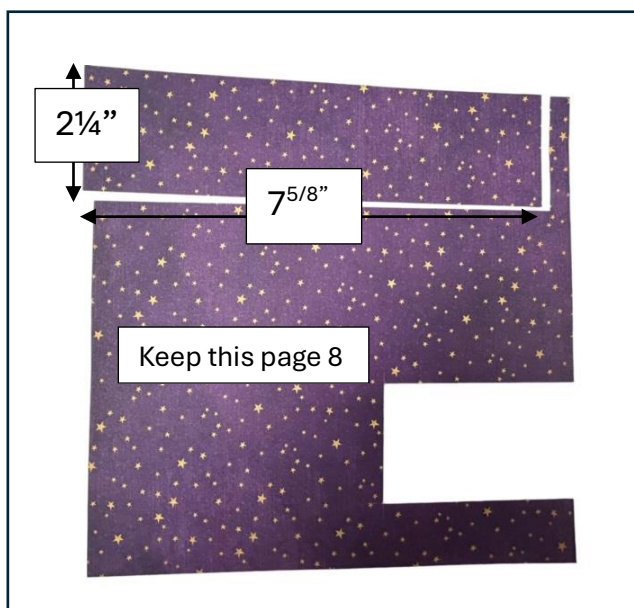

Mat the “ladies” paper from the top of the base page.

Mat the purple paper from the top of the bottom pocket and stick in place.

Mat the ladies paper onto the top pocket and stick in place.

**Page 7.** A “catch up” page with vertical pockets.



**8" x 8" paper** “Let’s Party”

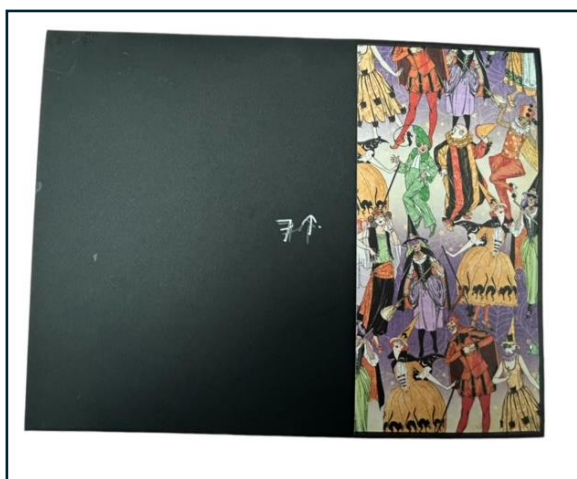

fig.53



fig.54

Mat the remainder ladies ( $2\frac{1}{8}$ ") in from the right hand edge of the page *fig.53*. Mat the striped paper onto the bottom pocket *fig.54*, then and and stick the top pocket.

**Page 8.**

This has a flip flap with photo slots with a swivel closure.



Front view

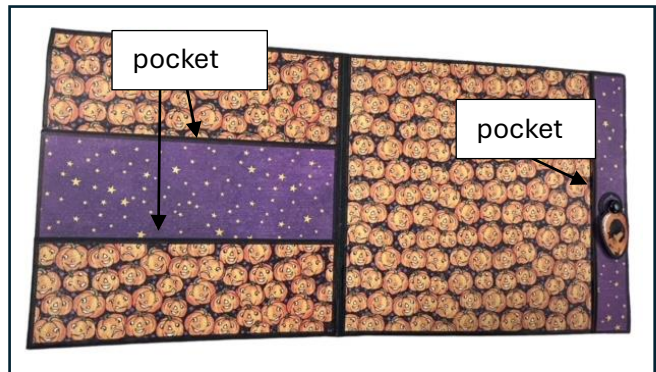

Flap opened out.

**8" x 8" papers**

“If the broomstick fits” x 2, “Hey Pumpkin”, purple paper from left overs.

Make up swivel mechanism.

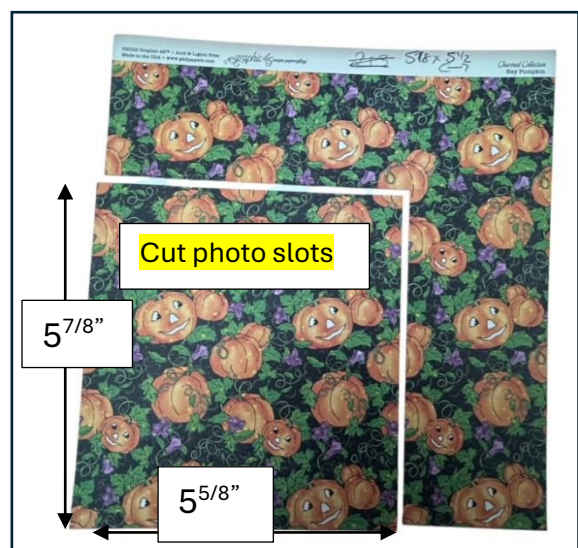
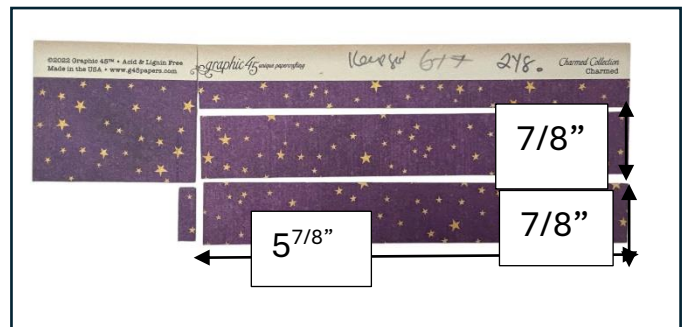
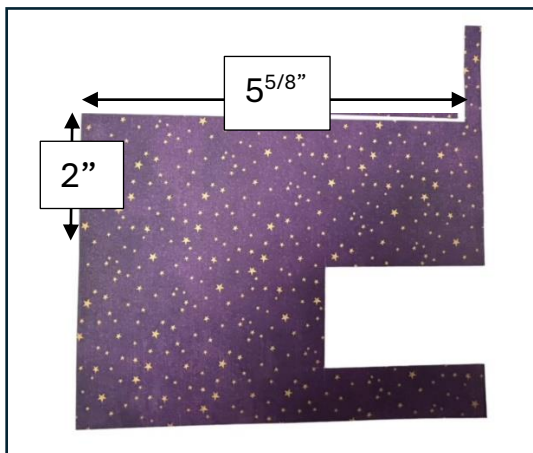

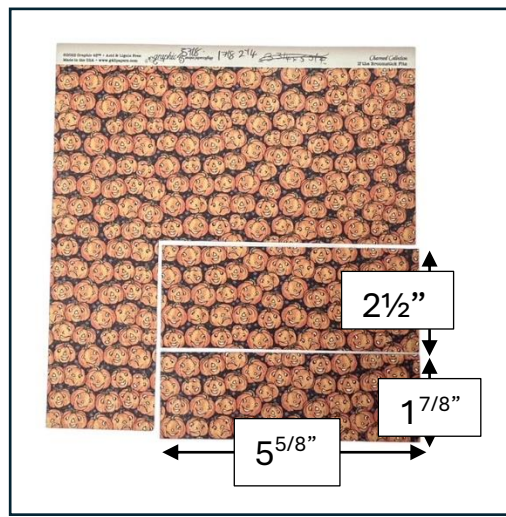
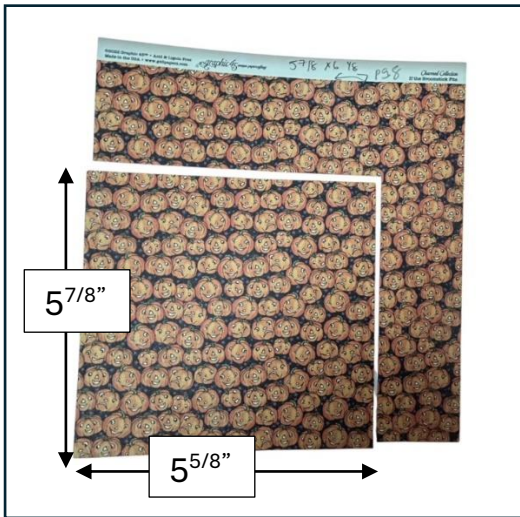

Mat the 5<sup>5/8</sup>" x 5<sup>5/8</sup>" pumpkin paper onto the base page.

Mat the stars paper onto the side of the flap, mat the other strip onto the black card, fix the swivel, then stick as the vertical pocket on the base page.

Stick the 2<sup>1/2</sup>" width strip from the top of the inside flap.

Mat the purple paper from the top of the black card and stick the bottom pocket.

Mat the pumpkin paper and then stick as a top pocket.

Cut photo slots and stick "Hey Pumpkin" onto the front flap.

Well done....you've completed all the album!

Before final assembly, decide how you want to decorate the front cover, adding any extra fussy cutting, embellishments, glossy accents etc.

Go through every page and add further embellishments, glossy accents etc before sticking in your pages and once you're happy with all the pages, put them in order making sure they are all the right way up. Make sure the pages slide easily onto the spine hinges, if they don't, you may need to trim the hinge angle a little more.

Starting from the back of the album, slide your page onto the spine hinge and stick firmly.

Let everything dry, then in a well lit area go through and check to see if any glue residue marks need removing (you can use an adhesive eraser). Make up the inner page tab inserts, photo mats etc.

There will be lots of decorative papers left, enough to do another project of your choice. Please don't forget to show us your completed project.

**Maggie & Kay.**